

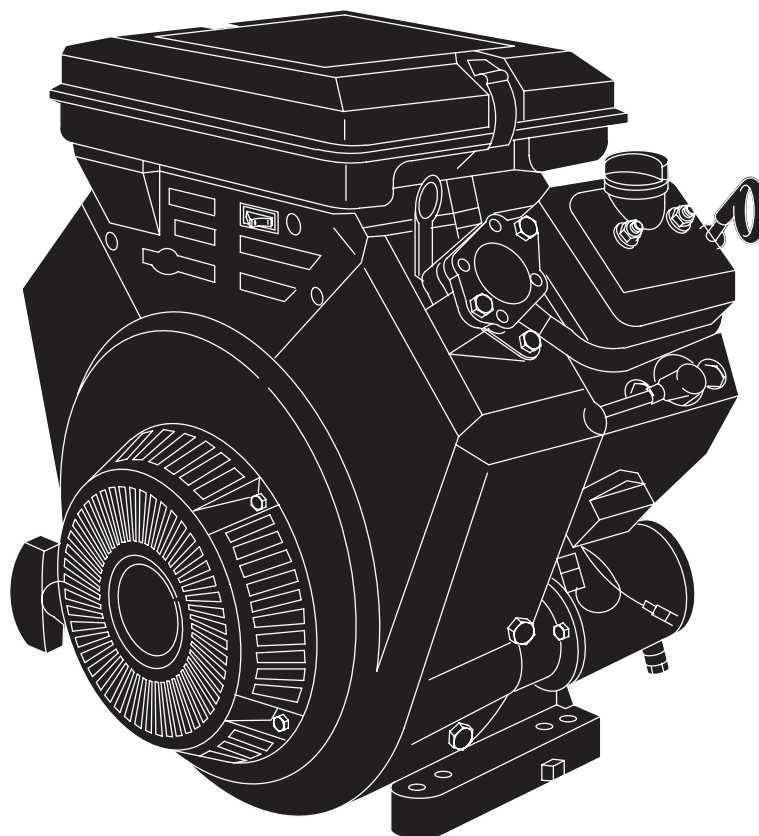



The Power That Works For You®

Operating & Maintenance Instructions



Model 290000 300000 350000 380000 Series covered in this manual

Safety References

The safety alert symbol  is used to identify safety information about hazards that can result in personal injury. A signal word (DANGER, WARNING, or CAUTION) is used with the alert symbol to indicate the likelihood and the potential severity of injury. In addition, a hazard symbol may be used to represent the type of hazard.



DANGER indicates a hazard which, if not avoided, **will result in death or serious injury**.



WARNING indicates a hazard which, if not avoided, **could result in death or serious injury**.



CAUTION indicates a hazard which, if not avoided, **might result in minor or moderate injury**.

CAUTION, when used **without** the alert symbol, indicates a situation that **could result in damage to the engine**.



This manual contains safety information to make you aware of the hazards and risks associated with engines, and how to avoid them. Because Briggs & Stratton does not necessarily know what equipment this engine will power, it is important that you read and understand these instructions and the instructions for the equipment this engine powers.

Table of Contents

Safety References	2
Features	3
Safety	4-5
Starting	6
Stopping	7
Oil	8-9
Fuel	10
Troubleshooting	11
Maintenance	12-14
Storage	15
Specifications	16
Warranty Information	17

SYMBOLS ASSOCIATED WITH THIS ENGINE:



Fire



Read Manual



Explosion



Oil



Kickback



Fuel



Hot Surface



Fuel Shut-off



Toxic Fumes



On Off



Moving Parts



Choke



Shock



Stop



Wear Eye Protection



Frostbite



WARNING

Briggs & Stratton does not approve or authorize the use of these engines on 3-wheel All Terrain Vehicles (ATVs), motor bikes, fun/recreational go-karts, aircraft products or vehicles intended for use in competitive events. Use of these engines in such applications could result in property damage, serious injury (including paralysis), or even death.



WARNING

The engine exhaust from this product contains chemicals known to the State of California to cause cancer, birth defects, or other reproductive harm.

CAUTION

This engine is shipped from Briggs & Stratton without oil. If you start the engine without oil, the engine will be damaged beyond repair and will not be covered under warranty.

Features

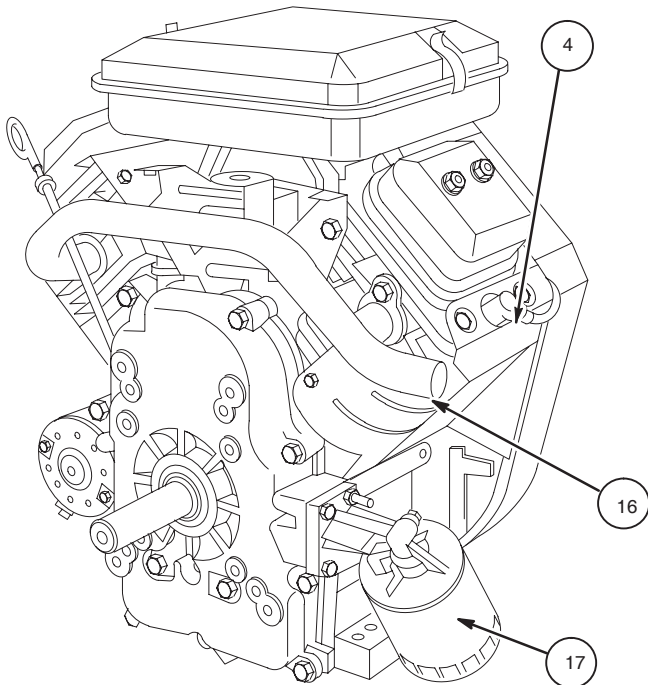
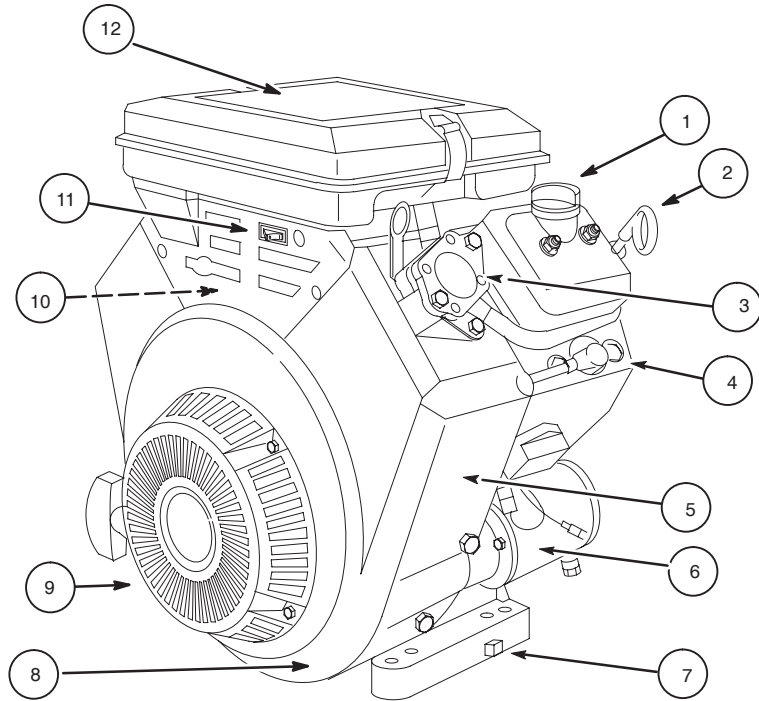

- 1. Oil Fill Cap
- 2. Dipstick
- 3. Fuel Pump (if equipped)
- 4. Spark Plug Wire
- 5. Emission Label and Engine Identification
**Model XXXXXX Type XXXXXX Code
XXXXXXXX**
- 6. 12V Electric Starter (if equipped)
- 7. Oil Drain Plug
- 8. Blower Housing
- 9. Rewind Starter (if equipped)
- 10. Carburetor or LPG / NG Fuel Mixer
- 11. Stop Switch (if equipped)
- 12. Air Cleaner (without fuel tank)
- 13. Fuel Shut-off Valve (if equipped)
- 14. Air Cleaner (with fuel tank)
- 15. Fuel Fill/Fuel Tank (if equipped)
- 16. Exhaust Manifold
- 17. Oil Filter (if equipped)



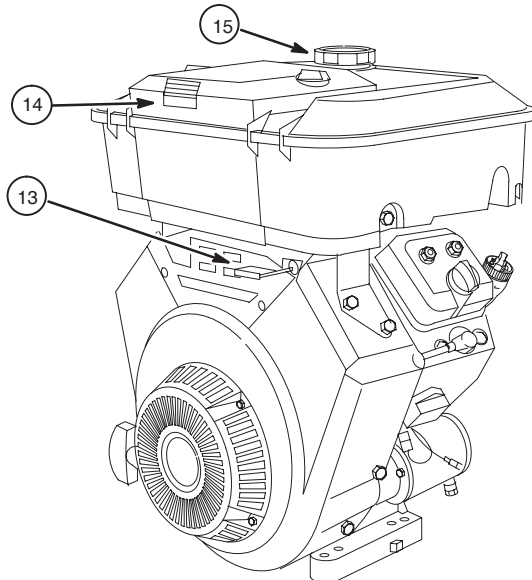





Equipped with optional fuel tank.



Safety

 	 WARNING Gasoline and its vapors are extremely flammable and explosive. Fire or explosion can cause severe burns or death.
WHEN ADDING FUEL <ul style="list-style-type: none">• Turn engine OFF and let engine cool at least 2 minutes before removing gas cap.• Fill fuel tank outdoors or in well-ventilated area.• Do not overfill fuel tank.• Keep gasoline away from sparks, open flames, pilot lights, heat, and other ignition sources.• Check fuel lines, tank, cap, and fittings frequently for cracks or leaks. Replace if necessary.	
WHEN STARTING ENGINE <ul style="list-style-type: none">• Make sure spark plug, muffler, fuel cap and air cleaner are in place.• Do not crank engine with spark plug removed.• If fuel spills, wait until it evaporates before starting engine.• If engine floods, set choke to OPEN/RUN position, place throttle in FAST and crank until engine starts.	
WHEN OPERATING EQUIPMENT <ul style="list-style-type: none">• Do not choke carburetor to stop engine.	
WHEN TRANSPORTING EQUIPMENT <ul style="list-style-type: none">• Transport with fuel tank EMPTY.	
WHEN STORING GASOLINE OR EQUIPMENT WITH FUEL IN TANK <ul style="list-style-type: none">• Store away from furnaces, stoves, water heaters or other appliances that have pilot light or other ignition source because they can ignite gasoline vapors.	

 	 WARNING Starting engine creates sparking. Sparking can ignite nearby flammable gases. Explosion and fire could result.
<ul style="list-style-type: none">• If there is natural or LP gas leakage in area, do not start engine.• Do not use pressurized starting fluids because vapors are flammable.	

 	 WARNING Gaseous fuels, such as liquid petroleum gas (LPG) and natural gas (NG), are extremely flammable and can readily form explosive air-vapor mixtures at moderate temperatures.
IF YOU SMELL GAS: <ul style="list-style-type: none">• DO NOT start the engine.• DO NOT actuate any electrical switches.• DO NOT use the phone in the vicinity.• Evacuate the area.• Contact the gas supplier or fire department.	
REMEMBER: <ul style="list-style-type: none">• LPG vapor is heavier than air and tends to collect in low areas. NG vapor is lighter than air and tends to collect in high areas. Both may travel to remote locations.• Keep all flames, sparks, pilot lights and other ignition sources away from the area where the engine is operated or repaired.• DO NOT smoke when operating or repairing the engine.• DO NOT store gasoline or other flammable vapors or liquids in the vicinity of the engine.• BEFORE doing any service work to the engine, shut off the gas supply.• After initial installation or servicing, check for gas leaks. DO NOT use an open flame. Apply very soapy water or leak test solution with a brush and look for bubbles.• Keep the equipment and the area surrounding the engine free of debris.• Install the fuel system according to applicable fuel/gas codes.	



WARNING

Rapid retraction of starter cord (kickback) will pull hand and arm toward engine faster than you can let go.

Broken bones, fractures, bruises or sprains could result.

- When starting engine, pull cord slowly until resistance is felt, then pull rapidly.
- Direct coupled equipment components such as, but not limited to, blades, impellers, pulleys, sprockets, etc., must be securely attached.



WARNING

Rotating parts can contact or entangle hands, feet, hair, clothing, or accessories.

Traumatic amputation or severe laceration can result.

- Operate equipment with guards in place.
- Keep hands and feet away from rotating parts.
- Tie up long hair and remove jewelry.
- Do not wear loose-fitting clothing, dangling drawstrings or items that could become caught.



WARNING

Engines give off carbon monoxide, an odorless, colorless, poison gas. Breathing carbon monoxide can cause nausea, fainting or death.

- Start and run engine outdoors.
- Do not start or run engine in enclosed area, even if doors or windows are open.



WARNING

Running engines produce heat. Engine parts, especially muffler, become extremely hot.

Severe thermal burns can occur on contact.

Combustible debris, such as leaves, grass, brush, etc. can catch fire.



- Allow muffler, engine cylinder and fins to cool before touching.
- Remove accumulated debris from muffler area and cylinder area.
- Install and maintain in working order a spark arrester before using equipment on forest-covered, grass-covered, brush-covered unimproved land. The state of California requires this (Section 4442 of the California Public Resources Code). Other states may have similar laws. Federal laws apply on federal land.



WARNING

Unintentional sparking can result in fire or electric shock.

Fire or explosion can cause severe burns or death.

Unintentional start-up can result in entanglement, traumatic amputation, or laceration.



Before performing maintenance or repairs:

- Disconnect spark plug wire and keep it away from spark plug.
- Disconnect battery at negative terminal (only engines with electric start).
- Use only correct tools.
- Do not strike the flywheel with a hammer or hard object because the flywheel may later shatter during operation.
- Do not tamper with governor spring, links or other parts to increase engine speed.

When testing for spark:

- Use approved spark plug tester.
- Do not check for spark with spark plug removed.



WARNING

Wear eye protection when doing repair work.

Frostbite can result from skin/eye contact with leaking LP liquid.



- Installation, adjustment and repair work should be done by a qualified technician.
- Flexible supply lines should be checked regularly to make sure they are in good condition. Replace damaged or leaking components.

Starting

Oil Pressure Switch

If engine is equipped with oil pressure switch, the switch will either activate a warning device or stop the engine when the engine runs low on oil. (Read the operating instructions supplied by equipment manufacturer to determine how your engine is equipped.)

Before Starting – Liquid Petroleum Gas (LPG) / Natural Gas (NG) Engines

The LPG/NG mixer is equipped with solenoid, fuel inlet, 12 volt connector, and equipped for a fuel lock-off valve. (Read the operating instructions supplied by equipment manufacturer to determine how your engine is equipped).

CAUTION

The manufacturer of the equipment on which this engine is installed specifies top speed at which the engine will be operated. DO NOT EXCEED this speed.

CAUTION

When operating on LPG fuel, 12 volts MUST be supplied to the connector.
When operating on NG fuel, 12 volts MUST NOT be supplied to connector. Failure to do so may cause engine damage.

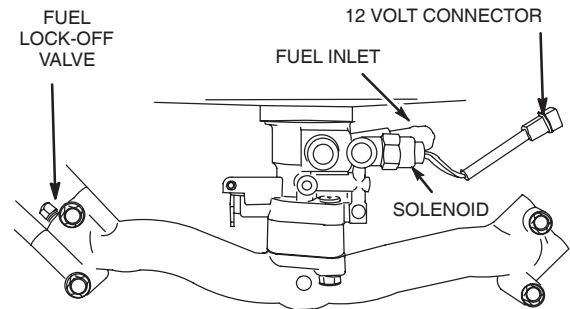

Starting – All Engines

1. Check oil level.

Note: LPG/NG Engines: Skip steps 2 and 3.

2. Open fuel shut-off valve (if equipped).
3. Pull choke control to CHOKE or START position.

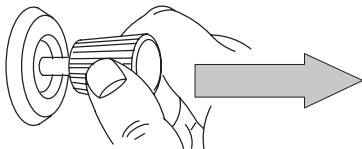

4. Move throttle (if equipped) to FAST position. Operate engine with throttle in FAST position and choke in RUN or OFF position.

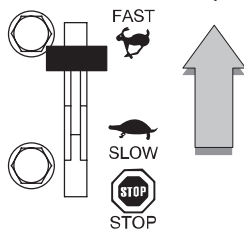

5. **REWIND (MANUAL) STARTER:** Grasp rope handle. Pull slowly until resistance is felt. Then pull rapidly to start engine and avoid kickback. Repeat if necessary with choke in OFF or RUN.

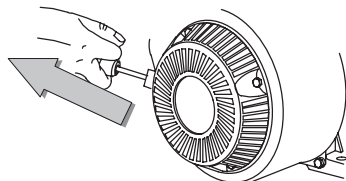

6. **ELECTRIC (KEY) STARTER:** Push rocker switch (if equipped) to ON or RUN.

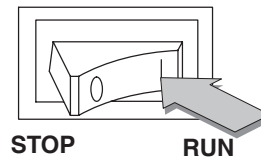

7. Insert key and turn to START.
8. Allow engine to warm up.

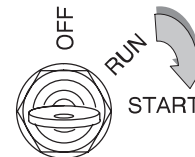

CAUTION

Use short starting cycles (5 seconds, wait one minute between cycles). Follow equipment manufacturer's recommendations for charging battery.

Note: Choke equipped: In warm weather temperatures, move choke control lever toward RUN slowly over several seconds, in cold weather allow engine to run smoothly before each change. Operate with choke in RUN.

Stopping

1. **REWIND (MANUAL) STARTER:** Move throttle control (if equipped) to SLOW and then STOP position.
2. **ELECTRIC (KEY) STARTER:** Move throttle lever (if equipped) to SLOW.

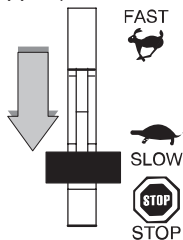

3. **ELECTRIC (KEY) STARTER:** Turn key to OFF. Remove key and store out of reach of children.

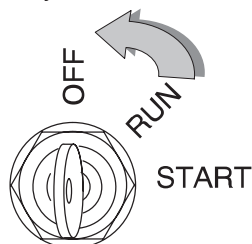

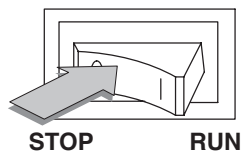

4. Push rocker switch (if equipped) to STOP.



5. Close fuel shut-off valve (if equipped).

Note: When engine is transported, close fuel shut-off valve (if equipped) to prevent leakage.

	 WARNING
<ul style="list-style-type: none">• Do not stop engine by moving choke control to CHOKE. Backfire, fire or engine damage could occur.	



Need Assistance?

Go to www.briggsandstratton.com or call 1-800-233-3723

Oil Capacity

Engine holds approximately 1-1/2 quarts (48 ounces or 1.4 liters) when changing oil and oil filter.

Oil Recommendation

- Use a high quality detergent oil classified “For Service SF, SG, SH, SJ” or higher. Briggs & Stratton strongly recommends the use of synthetic oil. If synthetic oil is unavailable, Briggs & Stratton non-synthetic 30 weight oil P/N 1000005 (20 oz.) or P/N 1000028 (48 oz.) is an acceptable substitute.
- Do not use special additives.
- Choose a viscosity according to the table below.



Note: Synthetic oil meeting ILSAC GF-2, API certification mark and API service symbol (shown at left) with “SJ/CF ENERGY CONSERVING” or higher, is an acceptable oil at all temperatures. **Use of synthetic oil does not alter required oil change intervals.**

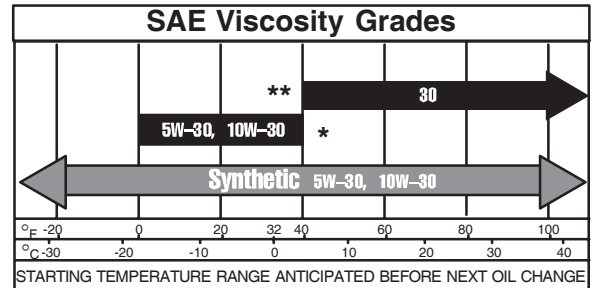

CAUTION

- * Air cooled engines run hotter than automotive engines. The use of non-synthetic multi-viscosity oils (5W-30, 10W-30, etc.) in temperatures above 40° F (4° C) will result in higher than normal oil consumption. When using a multi-viscosity oil, check oil level more frequently.
- ** SAE 30 oil, if used below 40° F (4° C), will result in hard starting and possible engine bore damage due to inadequate lubrication.

Checking and Adding Oil

- Check oil level before starting the engine.
- Keep oil level at FULL. Do not overfill.
- Check level daily, or after every eight (8) hours.

1. Place engine level and clean around oil fill and dipstick area.

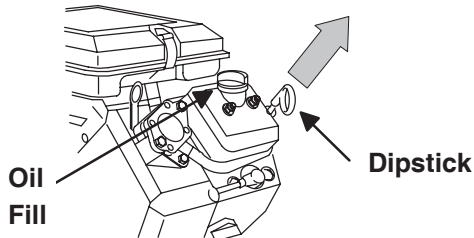

2. Remove dipstick and wipe with clean cloth. Then push dipstick back in and remove to check oil level.

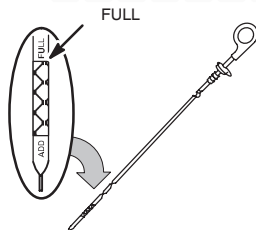

3. Remove oil fill cap. Pour oil slowly. First add 1 qt. (32 oz. or 1 liter). Start and run engine at idle for 30 seconds. Shut off engine and wait 30 seconds. Then add more oil slowly to bring level to FULL mark on dipstick.



4. Fill to FULL mark on dipstick. Recheck.

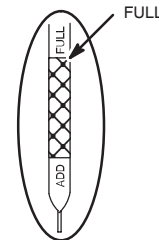

5. Replace dipstick firmly.

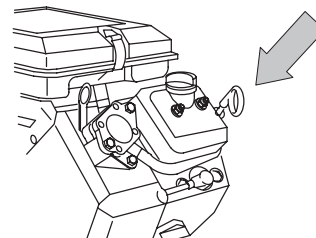

Changing Oil

Change oil after first 5 to 8 hours of use, then every 50 hours. Change oil every 25 hours when operating the engine under heavy load or in high temperatures.

1. Place engine level.
2. Disconnect spark plug wire and keep it away from spark plugs. Disconnect battery (if equipped with electric starter) at negative terminal.
3. With engine OFF but still warm remove oil drain plug and drain oil into appropriate receptacle.



PIPE

Typical drain plug

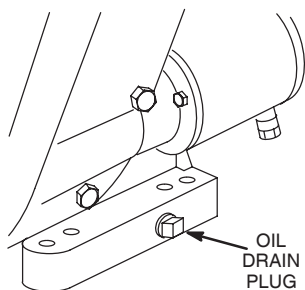

4. Reinstall drain plug. Remove oil fill cap.
5. **OIL FILLING PROCEDURE:** Add 1 quart (32 ounces or 1 liter). Start and run engine at idle for 30 seconds. Shut engine off and wait 30 seconds. Then add more oil slowly to bring level to FULL mark on dipstick. **Do not overfill.**

Note: Engine holds approximately 1-1/2 quarts (48 ounces or 1.4 liters) when changing oil and oil filter.

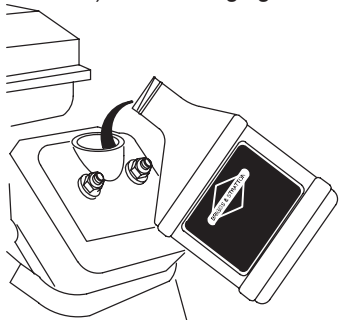

6. Reinstall oil fill cap (if equipped) and dipstick.

Oil Pressure

If oil pressure drops below 1-4 psi (0.1-0.2 kg/cm²), an oil pressure switch (if equipped) will either activate a warning device or stop the engine. Check oil level with dipstick. If oil level is between ADD and FULL mark on dipstick **do not try to restart engine**. Contact an authorized Briggs & Stratton Service Dealer. **Do not operate engine until oil pressure is corrected.**

If oil level is below ADD mark on dipstick, add oil to bring level to FULL mark. Restart engine and check oil pressure. If pressure is normal, continue to operate engine.

Note: Oil pressure gauge(if engine is equipped) is supplied by manufacturer of equipment.

CAUTION

Used oil is a hazardous waste product. Dispose of used oil properly. Do not discard with household waste. Check with your local authorities, service center, or dealer for safe disposal/recycling facilities.



WARNING

- To prevent unintentional starting, disconnect spark plug wire and keep it away from spark plug.

Changing Oil Filter (if equipped)

Change oil filter after every 100 hours or every season.

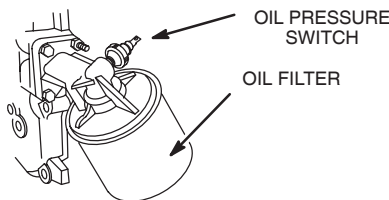

1. Drain engine oil and remove oil filter.
2. Before installing new filter, lightly oil filter gasket with fresh, clean oil.
3. Screw filter on by hand until gasket contacts oil filter adapter. Tighten 1/2 to 3/4 turn more.
4. Add fresh oil. Fill to FULL line on dipstick.
5. Start and run engine at idle to check for leaks.
6. Stop engine. Re-check oil level. Add oil if required.

Fuel

Gasoline Powered Engines

- Use clean, fresh, regular unleaded gasoline with a minimum of 85 octane. Fresh fuel prevents gum from forming in the fuel system or on essential carburetor parts. Purchase fuel in quantity that can be used within 30 days.
- For engine protection use Briggs & Stratton Gasoline Additive available from your Authorized Briggs & Stratton Dealer.
- Do not use gasoline which contains Methanol.
- Do not mix oil with gasoline.
- This engine is certified to operate on gasoline. Exhaust Emission Control System: EM (Engine Modifications).

Adding Fuel

1. Turn engine OFF and let engine cool at least 2 minutes before removing gas cap.
2. Remove cap. Fill tank to approximately 1-1/2 inches below top of neck to allow for fuel expansion. Be careful not to overfill.
3. Replace cap before starting.

CAUTION

Some fuels, called oxygenated or reformulated fuels, are fuels blended with alcohols or ethers. Excessive amounts of these blends can damage the fuel system or cause performance problems. If any undesirable operating symptoms occur, use gasoline with a lower percentage of alcohol or ether.

Liquid Propane Gas (LPG)

Natural Gas (NG) Powered Engines

- Use clean, dry fuel, free of moisture or any particulate material. Using fuels outside the following recommended values may cause performance problems.
- In engines set to run on LPG, commercial grade HD5 LPG is recommended. Recommended fuel composition is fuel with a minimum fuel energy of 2500 BTU's/ft³ with maximum propylene content of 5% and butane and heavier gas content of 2.5% and minimum propane content of 90%.
- LPG or NG engines are certified to operate on liquid propane gas or natural gas.

Adding Fuel

Read the operating instructions supplied by the equipment manufacturer for information on refueling natural or LP gas engine.





WARNING

LPG/NG Engines: The equipment on which this engine is mounted is equipped with an automatic safety gas "fuel lock-off" valve. DO NOT operate the equipment if the "fuel lock-off" valve is missing or inoperative.

Troubleshooting

Starter Handle will Not Pull

- Place equipment on flat level surface.
- Remove all external equipment/engine loads before starting engine.
- Direct coupled equipment components such as, but not limited to, blades, impellers, pulleys, sprockets, etc., must be securely attached.

	 WARNING
	<p>Rapid retraction of starter cord (kickback) will pull hand and arm toward engine faster than you can let go. Broken bones, fractures, bruises or sprains could result.</p>
<ul style="list-style-type: none">• When starting engine, pull cord slowly until resistance is felt, then pull rapidly.	

Engine will Not Start

Out of Fuel

- Add fuel to tank.



Engine Flooded

- **Gasoline Engine:** Set choke (if equipped) to OPEN/RUN position, and continue to pull starter handle.

Spark Plug Fouling

- Check and ensure the spark plug is clean. Check the gap with a feeler gauge and reset to .76 mm or .030 in. if necessary.
- If the electrode is burned or worn, replace spark plug with new spark plug.

CAUTION
<p>This engine is shipped from Briggs & Stratton without oil. If you start the engine without oil, the engine will be damaged beyond repair and will not be covered under warranty.</p>

 	 WARNING
	<ul style="list-style-type: none">• Ensure fuel cap is in place before starting engine• Turn engine OFF and let engine cool at least 2 minutes before removing fuel cap.• Check fuel lines, tank, cap, and fittings frequently for cracks or leaks. Replace if necessary.• Do not crank engine with spark plug removed.

Engine is Smoking or Running Rough

Engine may have been tipped during transport.

- Check for fouled spark plug.
- Check air cleaner filter for oil saturation. Squeeze pre-cleaner in clean, absorbant cloth to remove ALL EXCESS oil. If air cleaner is saturated, replace with new cartridge.



CAUTION
<p>If engine is tipped to transport equipment, to remove debris, to drain oil, etc., keep the spark plug side of engine up.</p>

Maintenance

Regular maintenance will improve the performance and extend the life of the engine. See any Authorized Briggs & Stratton Dealer for service. **Use only genuine Briggs & Stratton parts. Other parts may not perform as well, may damage the engine, and may result in injury.** In addition, use of other parts may void your warranty.

Emission Control

Maintenance, replacement or repair of the emission control devices and systems may be performed by any nonroad engine repair establishment or individual. However, to obtain no charge repairs under the terms and provisions of the Briggs & Stratton warranty statement, any service or emission control part repair or replacement must be performed by a factory authorized dealer.







 **WARNING**

Wear eye protection when doing repair work.

Frostbite can result from skin/eye contact with leaking LP liquid.

- Installation, adjustment and repair work should be done by a qualified technician.
- Flexible supply lines should be checked regularly to make sure they are in good condition. Replace damaged or leaking components.

 **WARNING**

Unintentional sparking can result in fire or electric shock.

Fire or explosion can cause severe burns or death.

Unintentional start-up can result in entanglement, traumatic amputation, or laceration.

Before performing maintenance or repairs:

- Disconnect spark plug wire and keep it away from spark plug.
- Disconnect battery at negative terminal (only engines with electric start).
- Use only correct tools.
- Do not strike the flywheel with a hammer or hard object because the flywheel may later shatter during operation.
- Do not tamper with governor spring, links or other parts to increase engine speed.

When testing for spark:

- Use approved spark plug tester.
- Do not check for spark with spark plug removed.

Follow the instructions and schedules indicated below.

Task	Every 8 Hours or Daily	25 Hours	50 Hours	100 Hours	100-400 Hours
Check Oil Level					
Service Air Cleaner Pre-cleaner*					
Change Oil **					
Inspect Spark Arrester (if equipped)					
Change Oil Filter (if equipped)					
Service Air Cleaner Cartridge*					
Clean Oil Cooler (if equipped)*					
Clean Cooling System*					
Check Valve Clearance on LPG/NG Engines					
Clean/Replace Spark Plugs					
Clean/Replace In-line Fuel Filter (if equipped)					
Check Valve Clearance					

* Clean more often under dusty conditions or when airborne debris is present. Replace air cleaner, if very dirty.

** **Change oil after first 5 to 8 hours of use**, then every 50 hours. Change oil every 25 hours when operating the engine under heavy load or in high temperatures.

Air Cleaner

All engines have a round air cleaner cartridge. In addition, some engines have a pre-cleaner.

CAUTION

Do not use pressurized air or solvents to clean cartridge. Pressurized air can damage cartridge; solvents will dissolve cartridge.

WARNING

Ensure air cleaner, retainer, and cover are properly installed before starting engine.

Pre-cleaner

To clean pre-cleaner (if equipped), separate it from cartridge and wash in liquid detergent and water. Squeeze dry in a clean cloth.

Removing and Installing Air Cleaner without Fuel Tank

1. Unhook clips on both sides of cover and remove cover.
2. Remove knob and plate. Carefully remove air cleaner assembly to prevent debris from entering carburetor.
3. Reassemble clean (or new) pre-cleaner on clean (or new) cartridge.
4. Reinstall air cleaner assembly, plate and knob in body.
5. Replace cover and reattach clips to body.

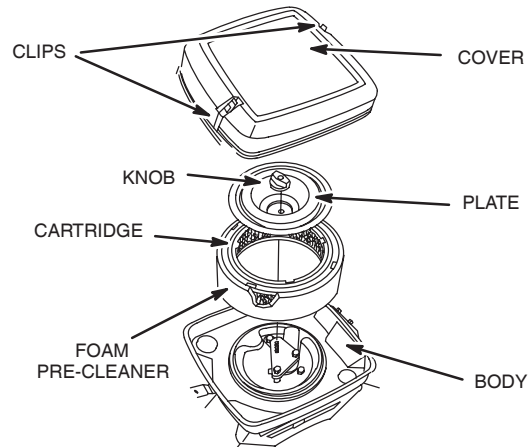

Removing and Installing Air Cleaner with Fuel Tank

1. Remove knobs and cover.
2. Remove nut, plate and carefully lift air cleaner assembly (pre-cleaner and cartridge) off stud.
3. Reinstall clean (or new) air cleaner assembly firmly in base. Reinstall plate (top side marked "UP") and nut.
4. Reinstall cover. Tighten knobs securely.

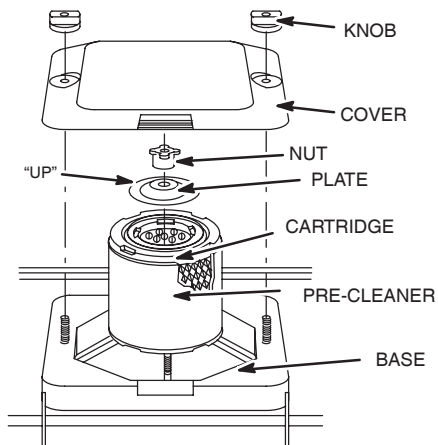

Spark Plug

Check the spark plug every 100 hours. Replace the spark plug if upon inspection the electrode ❶ is burned or worn. Ensure the spark plug is clean. Check the gap ❷ with a wire gauge ❸ and reset to .76 mm or 0.30 in. if necessary.

Note: In some areas, local law requires using resistor spark plug to suppress ignition signals. If this engine was originally equipped with resistor spark plug, use same type for replacement.

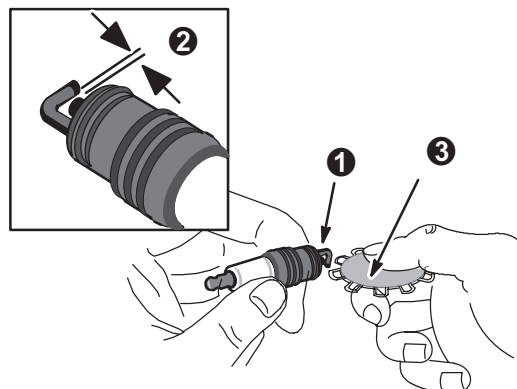

Cleaning Debris

Daily or before every use, clean accumulated debris from engine. Keep linkage, springs and controls clean. Keep area behind and around muffler free of any combustible debris.



Finger Guard



Rotating Screen



Spark Arrester

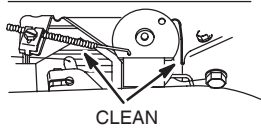

Linkage, Springs and Controls

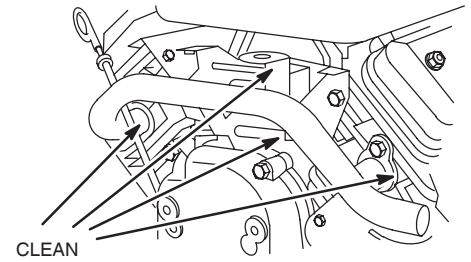

Muffler Area

Air Cooling System

Debris may clog the engine's air cooling system. Remove blower housing and clean area shown to prevent overheating and engine damage.

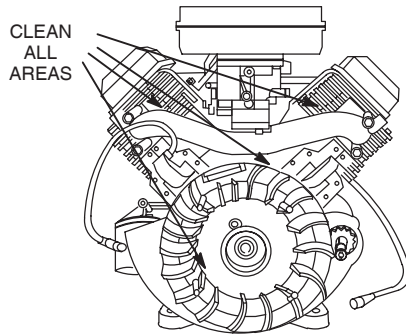

Muffler

If muffler is equipped with spark arrester screen, remove screen for inspection. Replace screen if damaged or plugged.

Fuel System

Replacing Fuel Filter (if equipped)

Drain Fuel tank or close fuel shut-off valve before replacing fuel filter. Otherwise, fuel can leak out creating a fire/explosion hazard.

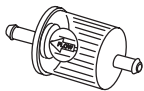

PART NO. 493629
(WITH FUEL PUMP)

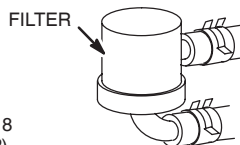

PART NO. 808116 (WITH
FUEL TANK, IF EQUIPPED)



PART NO. 298090 or 5018
(WITHOUT FUEL PUMP)

Oil Cooler (if equipped)

Clean oil cooler of all debris and chaff.

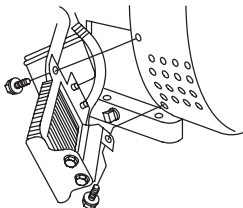

WARNING

- Engine parts should be kept clean to reduce the risk of overheating and ignition of accumulated debris.

CAUTION

Do not use water to clean engine parts. Water could contaminate fuel system. Use a brush or dry cloth.

CAUTION

All the components used to build this engine must remain in place for the proper operation of this engine.



WARNING

- Replacement parts for fuel system (cap, hoses, tanks, filters, etc.) and exhaust system (mufflers, arresters, etc.) must be the original parts, otherwise fire can occur.

Valve Clearance

Gasoline Engines: Check valve clearance yearly.

LPG/NG Engines: Valve clearance must be checked after every 100 hours of operation. Adjust if necessary.

Storage

- Engines stored over 30 days need to be protected or drained of fuel to prevent gum from forming in fuel system or on essential carburetor parts.
 - If fuel tank contains oxygenated or reformulated gasoline** (gasoline blended with an alcohol or an ether), run engine until it stops from lack of fuel.
 - If fuel tank contains gasoline**, either run engine until it stops from lack of fuel, or add a gasoline additive to the gas in tank.
- While engine is still warm, change oil.
- Remove spark plug and pour about 1 oz. (30ml) of engine oil into cylinder. Replace spark plug and crank slowly to distribute oil.
- Clean dirt and chaff from cylinder, cylinder head fins, blower housing and rotating screen areas.
- Store in a clean, dry area. Do not store in same area as a stove, furnace, water heater, or other appliance that uses a pilot light or has a device that can create a spark.

Service

See an Authorized Briggs & Stratton Service Dealer for all your engine service needs. Each one carries a stock of Genuine Briggs & Stratton Parts and is equipped with special service tools. Trained mechanics assure expert repair service on all Briggs & Stratton engines. Only dealers advertising as "Authorized Briggs & Stratton" are required to meet Briggs & Stratton standards.

When you purchase equipment powered by Briggs & Stratton, you are assured of highly skilled, reliable engine service at more than 30,000 Authorized Service Dealers worldwide, including more than 6,000 Master Service Technicians. Look for these signs wherever Briggs & Stratton service is offered.





You may find the nearest Authorized Service Dealer in our dealer locator map at

www.briggsandstratton.com, or by calling 1-800-233-3723

An illustrated shop manual includes common specifications and detailed information covering adjustment, tune-up and repair of Briggs & Stratton single cylinder, 4 cycle engines. It is available for purchase from an Authorized Briggs & Stratton Service Dealer or you can order it from

www.briggsandstratton.com.





WARNING

When storing fuel or equipment with fuel in tank:

- Store away from furnaces, stoves, water heaters, or other appliances that have a pilot light or other ignition source because they can ignite vapors.

When Transporting Equipment:

- Gasoline Engine:** Transport with fuel tank EMPTY or with fuel shut-off valve OFF.
- Liquid Petroleum Gas (LPG) /Natural Gas Engine:** Transport with fuel cylinder empty and valve closed or tank disconnected.

PARTIAL LIST OF GENUINE BRIGGS & STRATTON PARTS

<u>PART</u>	<u>PART NO.</u>
Air Filter Cartridge (without fuel tank)	394018
(model 380400, 381400 only – use 692519)	
Air Filter Pre-cleaner (without fuel tank)	272490
(model 380400, 381400 only – use 692520)	
Air Filter Pre-cleaner/Cartridge(without fuel tank)	5050D
(model 380400, 381400 only – use 5120A)	
Air Filter Cartridge (with fuel tank)	393957
Air Filter Pre-cleaner (with fuel tank)	271794
Oil	100005 -OR- 100028
Oil Filter (3-1/2 in. long)	491056
Oil Filter (2-1/4 in. long)	492932 -OR- 5049
Fuel Filter (with fuel pump)	493629
Fuel Filter (without fuel pump)	298090 -OR- 5018
Fuel Filter (with fuel tank)	808116
Gas Additive	5041
Resistor Spark Plug (Champion RC12YC)	491055
Resistor Spark Plug (Champion RC14YC)	496018
Long Life Platinum Spark Plug	5066
(used on most OHV engines)	
Spark Plug Wrench	19374
Spark Tester	19368
Oil Pump Kit	5056
(uses standard electric drill to remove oil from engine quickly)	

Specifications

We recommend that you use an authorized Briggs & Stratton Service Dealer for all maintenance and service of the engine and engine parts. Use only genuine Briggs & Stratton parts.

In the state of California, Model Series 290000, 300000, 350000 and 380000 engines are certified by the California Air Resources Board to meet emissions standards for 250 hours. Such certification does not grant the purchaser, owner or operator of this engine any additional warranties with respect to the performance or operational life of this engine. This engine is warranted solely according to the product and emissions warranties stated elsewhere in this manual.

Model Series 290000 and 300000

Bore 2.68 in. (68 mm)
Stroke 2.6 in. (66 mm)
Displacement 29.3 cu. in. (480 cc)

Model Series 350000

Bore 2.83 in. (72 mm)
Stroke 2.76 in. (70 mm)
Displacement 34.7 cu. in. (570 cc)

Model Series 380000

Bore 2.97 in. (75.5 mm)
Stroke 2.76 in. (70 mm)
Displacement 38.2 cu. in. (627 cc)

Tune-up Specifications

Models 200000/210000

Armature air gap . . . 0.008 – 0.012 in. (0.20 – 0.30 mm)
Spark plug gap 0.030 in. (0.76 mm)
Valve clearance with valve springs installed and piston 1/4 in. (6 mm) past top dead center (check when engine is cold). See Repair Manual P/N 272144.
Intake 0.004 – 0.006 in. (0.10 – 0.15 mm)
Exhaust 0.004 – 0.006 in. (0.10 – 0.15mm)

Note: For practical operation, the horsepower loading should not exceed 85% of rated horsepower. Engine power will decrease 3-1/2% for each 1,000 feet (300 meters) above sea level and 1% for each 10° F (5.6° C) above 77° F (25° C). It will operate satisfactorily at an angle up to 15°.

Model, Type and Code Number

To get replacement parts or technical assistance in the future write your engine Model, Type and Code number along with the date of purchase here. These numbers are located on your engine. For the location, see page 3, **Engine Features**.

Model Series

--	--	--	--	--	--	--

Type

--	--	--	--	--	--	--

Code

--	--	--	--	--	--	--	--	--	--

Technical Information

Power Ratings: The power ratings for an individual engine model are initially developed by starting with SAE (Society of Automotive Engineers) code J1940 (Small Engine Power & Torque Rating Procedure) (Revision 2002-05). Given both the wide array of products on which our engines are placed, and the variety of environmental issues applicable to operating the equipment, it may be that the engine you have purchased will not develop the rated horsepower when used in a piece of power equipment (actual “on-site” power). This difference is due to a variety of factors including, but not limited to, the following: differences in altitude, temperature, barometric pressure, humidity, fuel, engine lubrication, maximum governed engine speed, individual engine to engine variability, design of the particular piece of power equipment, the manner in which the engine is operated, engine run-in to reduce friction and clean out of combustion chambers, adjustments to the valves and carburetor, and other factors. The power ratings may also be adjusted based on comparisons to other similar engines utilized in similar applications, and will therefore not necessarily match the values derived using the foregoing codes.

Emission Information

Engines that are certified to meet the California Air Resources Board (CARB) Tier 2 Emission Standards must display information regarding the Emissions Durability Period and the Air Index. Briggs & Stratton makes this information available to the consumer on our emission labels. The engine emission label will indicate certification information.

The **Emissions Durability Period** describes the number of hours of actual running time for which the engine is certified to be emissions compliant, assuming proper maintenance in accordance with the Operating & Maintenance Instructions. The following categories are used:

Moderate:

Engine is certified to be emission compliant for 125 hours of actual engine running time.

Intermediate:

Engine is certified to be emission compliant for 250 hours of actual engine running time.

Extended:

Engine is certified to be emission compliant for 500 hours of actual engine running time. For example, a typical walk-behind lawn mower is used 20 to 25 hours per year. Therefore, the **Emissions Durability Period** of an engine with an **intermediate** rating would equate to 10 to 12 years.

Certain Briggs & Stratton engines will be certified to meet the United States Environmental Protection Agency (USEPA) Phase 2 emission standards. For Phase 2 certified engines, the Emissions Compliance Period referred to on the Emissions Compliance label indicates the number of operating hours for which the engine has been shown to meet Federal emission requirements.

For engines less than 225 cc displacement.

Category C = 125 hours

Category B = 250 hours

Category A = 500 hours

For engines of 225 cc or more displacement.

Category C = 250 hours

Category B = 500 hours

Category A = 1000 hours.

Warranty Information

Briggs & Stratton Corporation (B&S), the California Air Resources Board (CARB) and the United States Environmental Protection Agency (U.S. EPA) Emission Control System Warranty Statement (Owner's Defect Warranty Rights and Obligations)

The California Air Resources Board (CARB), U.S. EPA and B&S are pleased to explain the Emission Control System Warranty on your small off-road engine (SORE). In California, new small off-road engines model year 2006 and later must be designed, built and equipped to meet the State's stringent anti-smog standards.

Elsewhere in the United States, new non-road, spark-ignition engines certified for model year 1997 and later must meet similar standards set forth by the U.S. EPA. B&S must warrant the emission control system on your engine for the periods of time

listed below, provided there has been no abuse, neglect or improper maintenance of your small off-road engine.

Your emission control system includes parts such as the carburetor, air cleaner, ignition system, fuel line, muffler and catalytic converter. Also included may be connectors and other emission related assemblies.

Where a warrantable condition exists, B&S will repair your small off-road engine at no cost to you including diagnosis, parts and labor.

Briggs & Stratton Emission Control Defects Warranty Coverage

Small off-road engines are warranted relative to emission control parts defects for a period of two years, subject to provisions set forth below. If any covered part on your engine is defective, the part will be repaired or replaced by B&S.

Owner's Warranty Responsibilities

As the small off-road engine owner, you are responsible for the performance of the required maintenance listed in your Operating and Maintenance Instructions. B&S recommends that you retain all your receipts covering maintenance on your small off-road engine, but B&S cannot deny warranty solely for the lack of receipts or for your failure to ensure the performance of all scheduled maintenance.

As the small off-road engine owner, you should however be aware that B&S may deny you warranty coverage if your small off-road engine or a part has failed due to abuse, neglect, improper maintenance or unapproved modifications.

You are responsible for presenting your small off-road engine to an Authorized B&S Service Dealer as soon as a problem exists.

The undisputed warranty repairs should be completed in a reasonable amount of time, not to exceed 30 days.

If you have any questions regarding your warranty rights and responsibilities, you should contact a B&S Service Representative at 1-414-259-5262.

The emission warranty is a defects warranty. Defects are judged on normal engine performance. The warranty is not related to an in-use emission test.

Briggs & Stratton Emission Control Defects Warranty Provisions

The following are specific provisions relative to your Emission Control Defects Warranty Coverage. It is in addition to the B&S engine warranty for non-regulated engines found in the Operating and Maintenance Instructions.

1. Warranted Parts

Coverage under this warranty extends only to the parts listed below (the emission control systems parts) to the extent these parts were present on the engine purchased.

a. Fuel Metering System

- Cold start enrichment system
- Carburetor and internal parts
- Fuel pump
- Fuel line, fuel line fittings, clamps

b. Air Induction System

- Air cleaner
- Intake manifold

c. Ignition System

- Spark plug(s)
- Magneto ignition system

d. Catalyst System

- Catalytic converter
- Exhaust manifold
- Air injection system, Pulse valve

e. Miscellaneous Items

- Vacuum, temperature, position, time sensitive valves and switches
- Connectors and assemblies

2. Length of Coverage

B&S warrants to the initial owner and each subsequent purchaser that the Warranted Parts shall be free from defects in materials and workmanship which caused the failure of the Warranted Parts for a period of two years from the date the engine is delivered to a retail purchaser.

3. No Charge

Repair or replacement of any Warranted Part will be performed at no charge to the owner, including diagnostic labor which leads to the determination that a Warranted Part is defective, if the diagnostic work is performed at an Authorized B&S Service Dealer. For emissions warranty service contact your nearest Authorized B&S Service

Dealer as listed in the "Yellow Pages" under "Engines, Gasoline," "Gasoline Engines," "Lawn Mowers," or similar category.

4. Claims and Coverage Exclusions

Warranty claims shall be filed in accordance with the provisions of the B&S Engine Warranty Policy. Warranty coverage shall be excluded for failures of Warranted Parts which are not original B&S parts or because of abuse, neglect or improper maintenance as set forth in the B&S Engine Warranty Policy. B&S is not liable to cover failures of Warranted Parts caused by the use of add-on, non-original, or modified parts.

5. Maintenance

Any Warranted Part which is not scheduled for replacement as required maintenance or which is scheduled only for regular inspection to the effect of "repair or replace as necessary" shall be warranted as to defects for the warranty period. Any Warranted Part which is scheduled for replacement as required maintenance shall be warranted as to defects only for the period of time up to the first scheduled replacement for that part. Any replacement part that is equivalent in performance and durability may be used in the performance of any maintenance or repairs. The owner is responsible for the performance of all required maintenance, as defined in the B&S Operating and Maintenance Instructions.

6. Consequential Coverage

Coverage hereunder shall extend to the failure of any engine components caused by the failure of any Warranted Part still under warranty.

BRIGGS & STRATTON ENGINE OWNER WARRANTY POLICY

Effective July 1, 2004 replaces all undated Warranties and all Warranties dated before July 1, 2004

LIMITED WARRANTY

Briggs & Stratton Corporation will repair or replace, free of charge, any part(s) of the engine that is defective in material or workmanship or both. Transportation charges on parts submitted for repair or replacement under this warranty must be borne by purchaser. This warranty is effective for the time periods and subject to the conditions stated below. For warranty service, find the nearest Authorized Service Dealer in our dealer locator map at www.briggsandstratton.com, or by calling 1-800-233-3723, or as listed in the "Yellow Pages™".

THERE IS NO OTHER EXPRESS WARRANTY. IMPLIED WARRANTIES, INCLUDING THOSE OF MERCHANTABILITY AND FITNESS FOR A PARTICULAR PURPOSE, ARE LIMITED TO ONE YEAR FROM PURCHASE, OR TO THE EXTENT PERMITTED BY LAW ANY AND ALL IMPLIED WARRANTIES ARE EXCLUDED. LIABILITY FOR INCIDENTAL OR CONSEQUENTIAL DAMAGES ARE EXCLUDED TO THE EXTENT EXCLUSION IS PERMITTED BY LAW. Some states or countries do not allow limitations on how long an implied warranty lasts, and some states or countries do not allow the exclusion or limitation of incidental or consequential damages, so the above limitation and exclusion may not apply to you. This warranty gives you specific legal rights and you may also have other rights which vary from state to state and country to country.

OUR PRODUCT

Vanguard™	ELS™ I/C® Industrial Plus™ Intek™ (Sleeve Bore)	Fource™ Intek™ (Kool Bore) Power Built™ OHV Quantum® Quattro™ Q45™ Sprint™	Classic™	Etek™
------------------	--	---	-----------------	--------------

WARRANTY PERIOD*

Consumer Use	2 years	2 years	2 years	1 year	1 year
Commercial Use	2 years	1 year	90 days	90 days	1 year

* **Note the following special warranty periods: 2 years** for Classic™ engines in the European Union and Eastern European countries, for all consumer products in the European Union, and for emission control systems on engines certified by EPA and CARB. **5 years** for consumer use, 90 days for commercial use of Touch-N-Mow® starter on Quantum® and Intek™ engines. **Engines used in competitive racing or on commercial or rental tracks are not warrantied.** Engines operating on Kerosene fuel carry a one year for consumer use, 90 days for commercial use.

The warranty period begins on the date of purchase by the first retail consumer or commercial end user, and continues for the period of time stated in the table above. "Consumer use" means personal residential household use by a retail consumer. "Commercial use" means all other uses, including use for commercial, income producing or rental purposes. Once an engine has experienced commercial use, it shall thereafter be considered as a commercial use engine for purposes of this warranty.

NO WARRANTY REGISTRATION IS NECESSARY TO OBTAIN WARRANTY ON BRIGGS & STRATTON PRODUCTS. SAVE YOUR PROOF OF PURCHASE RECEIPT. IF YOU DO NOT PROVIDE PROOF OF THE INITIAL PURCHASE DATE AT THE TIME WARRANTY SERVICE IS REQUESTED, THE MANUFACTURING DATE OF THE PRODUCT WILL BE USED TO DETERMINE THE WARRANTY PERIOD.

Briggs & Stratton Engines Are Made Under One Or More Of The Following Patents: Design D-247,177 (Other Patents Pending)									
6,691,683	6,472,790	6,239,709	6,040,767	5,765,713	5,503,125	5,197,425	4,977,879	4,453,507	
6,647,942	6,460,502	6,237,555	6,014,808	5,732,555	5,501,203	5,197,422	4,977,877	4,430,984	
6,622,683	6,456,515	6,230,678	6,012,420	5,645,025	5,497,679	5,191,864	4,971,219	D 476,629	
6,615,787	6,382,166	6,213,083	5,992,367	5,642,701	5,320,795	5,188,069	4,895,119	D 457,891	
6,617,725	6,369,532	6,202,616	5,994,124	5,628,352	5,301,643	5,186,142	4,875,448	D 368,187	
6,603,227	6,356,003	6,145,487	5,994,715	5,619,845	5,271,363	5,150,674	4,819,593	D 375,963	
6,595,897	6,349,888	6,142,257	5,887,678	5,606,948	5,269,713	5,138,996	4,720,638	D 309,457	
6,595,176	6,347,614	6,135,426	5,852,951	5,606,851	5,265,700	5,086,890	4,719,682	D 372,871	
6,584,964	6,325,036	6,116,212	5,843,345	5,605,130	5,243,878	5,070,829	4,633,556	D 361,771	
6,557,833	6,311,663	6,105,548	5,823,153	5,497,679	5,235,943	5,058,544	4,630,498	D 356,951	
6,542,074	6,284,123	6,347,614	5,819,513	5,548,955	5,234,038	5,040,644	4,522,080	D 309,457	
6,520,141	6,263,852	6,082,323	5,813,384	5,546,901	5,228,487	5,009,208	4,520,288	D 308,872	
6,495,267	6,260,529	6,077,063	5,809,958	5,445,014	5,197,426	4,996,956	4,512,499	D 308,871	
6,494,175	6,242,828	6,064,027	5,803,035						

ABOUT YOUR ENGINE WARRANTY

Briggs & Stratton welcomes warranty repair and apologizes to you for being inconvenienced. Any Authorized Service Dealer may perform warranty repairs. Most warranty repairs are handled routinely, but sometimes requests for warranty service may not be appropriate. For example, warranty would not apply if engine damage occurred because of misuse, lack of routine maintenance, shipping, handling, warehousing or improper installation. Similarly, warranty is void if the serial number of the engine has been removed or the engine has been altered or modified.

If a customer differs with the decision of the Service Dealer, an investigation will be made to determine whether the warranty applies. Ask the Service Dealer to submit all supporting facts to his Distributor or the Factory for review. If the Distributor or the Factory decides that the claim is justified, the customer will be fully reimbursed for those items that are defective. To avoid misunderstanding which might occur between the customer and the Dealer, listed below are some of the causes of engine failure that the warranty does not cover.

Normal wear:

Engines, like all mechanical devices, need periodic parts service and replacement to perform well. Warranty will not cover repair when normal use has exhausted the life of a part or an engine.

Improper maintenance:

The life of an engine depends upon the conditions under which it operates, and the care it receives. Some applications, such as tillers, pumps and rotary mowers, are very often used in dusty or dirty conditions, which can cause what appears to be premature wear. Such wear, when caused by dirt, dust, spark plug cleaning grit, or other abrasive material that has entered the engine because of improper maintenance, is not covered by warranty.

This warranty covers engine related defective material and/or workmanship only, and not replacement or refund of the equipment to which the engine may be mounted. Nor does the warranty extend to repairs required because of:

1. PROBLEMS CAUSED BY PARTS THAT ARE NOT ORIGINAL BRIGGS & STRATTON PARTS.
2. Equipment controls or installations that prevent starting, cause unsatisfactory engine performance, or shorten engine life. (Contact equipment manufacturer.)
3. Leaking carburetors, clogged fuel pipes, sticking valves, or other damage, caused by using contaminated or stale fuel. (Use clean, fresh, lead-free gasoline and Briggs & Stratton Fuel Stabilizer, Part No. 5041.)
4. Parts which are scored or broken because an engine was operated with insufficient or contaminated lubricating oil, or an incorrect grade of lubricating oil (check oil level daily or after every 8 hours of operation. Refill when necessary and change at recommended intervals.) OIL GARD® may not shut down running engine. Engine damage may occur if oil level is not properly maintained. Read Operating & Maintenance Instructions.
5. Repair or adjustment of associated parts or assemblies such as clutches, transmissions, remote controls, etc., which are not manufactured by Briggs & Stratton.
6. Damage or wear to parts caused by dirt, which entered the engine because of improper air cleaner maintenance, re-assembly, or use of a non-original air cleaner element or cartridge. (At recommended intervals, clean and re-oil the Oil-Foam element or the foam pre-cleaner, and replace the cartridge.) Read Operating & Maintenance Instructions.
7. Parts damaged by over-speeding, or overheating caused by grass, debris, or dirt, which plugs or clogs the cooling fins, or flywheel area, or damage caused by operating the engine in a confined area without sufficient ventilation. (Clean fins on the cylinder, cylinder head and flywheel at recommended intervals.) Read Operating & Maintenance Instructions.
8. Engine or equipment parts broken by excessive vibration caused by a loose engine mounting, loose cutter blades, unbalanced blades or loose or unbalanced impellers, improper attachment of equipment to engine crankshaft, over-speeding or other abuse in operation.
9. A bent or broken crankshaft, caused by striking a solid object with the cutter blade of a rotary lawn mower, or excessive v-belt tightness.
10. Routine tune-up or adjustment of the engine.
11. Engine or engine component failure, i.e., combustion chamber, valves, valve seats, valve guides, or burned starter motor windings, caused by the use of alternate fuels such as, liquified petroleum, natural gas, altered gasolines, etc.

Warranty is available only through service dealers which have been authorized by Briggs & Stratton Corporation. your nearest Authorized Service Dealer is listed in the "Yellow Pages™" of your telephone directory under "Engines, Gasoline" or "Gasoline Engines," "Lawn Mowers," or similar category.

Déclaration de garantie du système de contrôle des émissions de Briggs & Stratton Corporation (B&S), du California Air Resources Board (CARB) et de la United States Environmental Protection Agency (U.S. EPA) (Droits et obligations du propriétaire au titre de la garantie contre tout défaut)

Déclaration de garantie pour les défauts de contrôle d'émissions pour la Californie, les États-Unis et le Canada.

Le California Air Resources Board (CARB), U.S. EPA et B&S ont le plaisir de vous expliquer la garantie du système de contrôle des émissions pour votre petit moteur tout terrain. En Californie, les petits moteurs tout terrain à partir de l'année 2006 doivent être conçus, fabriqués et équipés pour répondre aux normes sévères antibrouillard de l'état. Ailleurs aux États-Unis, les nouveaux moteurs tout terrain à allumage commandé par bougie depuis l'année 1997 doivent répondre à des normes semblables édictées par la U.S. EPA. B&S doit garantir le système de contrôle des émissions de votre moteur pendant les durées indiquées ci-après, en supposant que le petit moteur tout terrain ne soit pas mal utilisé, négligé ou que son entretien ne soit pas défectueux.

Le système de contrôle des émissions comprend des pièces comme le carburateur, le filtre à air, le système d'allumage, la Durit de carburant, le silencieux et le convertisseur catalytique. Des connecteurs et d'autres assemblages impliqués dans les émissions peuvent aussi en faire partie.

Si la condition de garantie est remplie, Briggs & Stratton réparera gratuitement votre moteur y compris le diagnostic, les pièces et la main-d'œuvre.

Couverture de la garantie de défectuosité du contrôle des émissions de Briggs & Stratton

Les petits moteurs tout terrain sont garantis en ce qui concerne les défauts des pièces du contrôle d'émission pendant une période de deux ans, aux conditions énoncées plus loin. Si une pièce de votre moteur couverte par cette garantie est défectueuse, Briggs et Stratton la réparera ou la remplacera.

Responsabilités du propriétaire au titre de la garantie

En tant que propriétaire d'un petit moteur non routier, vous êtes responsable de l'entretien nécessaire indiqué dans les instructions de fonctionnement et d'entretien. Briggs & Stratton recommande de conserver toutes les factures de maintenance de votre moteur, mais Briggs & Stratton ne peut renier la garantie uniquement à cause de l'absence de factures.

En tant que propriétaire d'un moteur non routier, vous devez néanmoins savoir que Briggs & Stratton peut refuser d'appliquer la garantie si la défectuosité de votre moteur ou d'une partie de ce moteur est due à un abus, une négligence, un entretien non correct ou des modifications non approuvées.

Vous avez la responsabilité de confier votre moteur à un Réparateur Agréé Briggs & Stratton dès que vous découvrez un problème. Les réparations incontestables sous garantie seront effectuées en un temps raisonnable qui ne doit pas excéder 30 jours.

Si vous avez des questions au sujet de vos droits ou de vos responsabilités quant à la garantie, veuillez contacter un représentant de Briggs & Stratton au 1-414-259-5262. La garantie d'émission est une garantie contre des défectuosités. Les défectuosités sont jugées en fonction des performances normales d'un moteur. La garantie n'est pas liée à un test d'émission en fonctionnement.

Dispositions de la garantie de défectuosité du contrôle des émissions de Briggs & Stratton

Suivent les dispositions particulières de la couverture de la garantie de défectuosité du contrôle des émissions. Elles viennent en complément de la garantie des moteurs Briggs & Stratton pour les moteurs non réglementés qui se trouve dans les instructions de fonctionnement et d'entretien.

1. Pièces garanties

La couverture au titre de cette garantie ne s'étend qu'aux pièces énumérées ci-dessous (celles du système de contrôle des émissions) dans la mesure où ces pièces étaient présentes dans le moteur au moment de l'achat.

- a. Système de dosage du carburant
 - Système d'enrichissement pour démarrages à froid (starter)
 - Carburateur et pièces internes
 - Pompe à carburant
 - Durit et raccords de carburant, colliers
- b. Système d'admission d'air
 - Filtre à air
 - Collecteur d'admission
- c. Système d'allumage
 - Bougie(s)
 - Système d'allumage par volant magnétique
- d. Système catalytique
 - Convertisseur catalytique
 - Collecteur d'échappement
 - Système d'injection d'air ou soupape d'impulsion
- e. Pièces diverses utilisées dans les systèmes ci-dessus
 - Soupapes et contacteurs de dépression, de température, de position et de durée.
 - Raccords et assemblages

2. Durée de la couverture

Briggs & Stratton garantit au propriétaire initial et à tous les acheteurs suivants les pièces contre tout défaut de matière ou de fabrication qui pourrait entraîner une défectuosité des pièces garanties pendant une période de deux ans à partir de la date de livraison du moteur à un acheteur individuel.

3. Gratuité

La réparation ou le remplacement de toute pièce garantie s'effectuera gratuitement pour l'acheteur, y compris les frais de diagnostic permettant de déterminer qu'une pièce garantie est défectueuse, si le diagnostic est effectué par un Réparateur Agréé Briggs & Stratton. Pour bénéficier du service de garantie, veuillez contacter le Réparateur Agréé Briggs & Stratton le plus proche de chez vous listé dans les Pages Jaunes sous la rubrique « moteurs, essence », « moteurs à essence », « tondeuses à gazon » ou autre catégorie semblable.

4. Réclamations et exclusions de garantie

Les réclamations sous garantie seront présentées selon les dispositions de la police de garantie des moteurs de Briggs & Stratton. La garantie ne couvre pas les pièces qui ne sont pas des pièces Briggs & Stratton d'origine ou qui ont fait l'objet d'abus, de négligence ou d'un mauvais entretien ainsi qu'indiqué dans la police de garantie des moteurs de Briggs & Stratton. Briggs & Stratton n'est pas responsable des défaillances dues à l'utilisation de pièces rajoutées, non d'origine ou modifiées.

5. Entretien

Toute pièce garantie qui ne doit pas être remplacée au titre de l'entretien ou qui est sujette à une inspection régulière avec la mention « réparer ou remplacer si besoin est » est garantie contre tout défaut pendant la période de garantie. Toute pièce dont le remplacement est prévu au titre de l'entretien n'est garantie contre tout défaut que pendant sa période normale d'utilisation. Les opérations de maintenance et de réparation doivent utiliser des pièces équivalentes sur le plan des performances et de la longévité. Le propriétaire est responsable de l'entretien défini dans les instructions de fonctionnement et d'entretien de Briggs & Stratton.

6. Couverture des conséquences

La présente couverture s'étend à la défaillance de tout composant du moteur due à la défaillance d'une pièce encore sous garantie.

Consultez les informations sur la période de durabilité des émissions et l'indice d'air sur l'étiquette d'émissions de votre moteur

Les moteurs qui sont certifiés conformes aux normes d'émissions du California Air Resources Board (CARB) Phase 2 doivent afficher l'information concernant la période de durabilité des émissions et l'indice d'air. Cette information est indiquée sur les étiquettes apposées sur les moteurs par Briggs & Stratton. L'étiquette du moteur indique les informations de certification.

La **période de durabilité des émissions** indique le nombre d'heures d'utilisation normale pour lequel le moteur est certifié conforme aux normes d'émissions sous réserve d'un entretien approprié tel qu'indiqué dans le manuel d'utilisation et d'entretien. Les catégories suivantes sont utilisées :

Modérée :

le moteur est certifié conforme pour 125 heures d'utilisation normale.

Intermédiaire :

le moteur est certifié conforme pour 250 heures d'utilisation normale.

Prolongée :

le moteur est certifié conforme pour 500 heures d'utilisation normale. Par exemple, une tondeuse à conducteur marchant classique est utilisée 20 à 25 heures par an. Par conséquent, la **période de durabilité des émissions** d'un moteur de catégorie **intermédiaire** équivaudrait à une douzaine d'années.

Certains moteurs Briggs & Stratton seront certifiés conformes aux normes environnementales d'émissions de la United States Environmental Protection Agency (USEPA) Phase 2, Classe IV. Pour les moteurs certifiés Phase 2, Classe IV, la période de conformité d'émissions mentionnée sur les étiquettes indique le nombre d'heures d'utilisation pour lequel le moteur est en conformité avec les normes fédérales.

Pour les moteurs de cylindrée inférieure à 225 cm³.

Catégorie C = 125 heures
Catégorie B = 250 heures
Catégorie A = 500 heures

Pour les moteurs de plus de 225 cm³.

Catégorie C = 250 heures
Catégorie B = 500 heures
Catégorie A = 1000 heures